

Standard Formkoder

Formkode 0

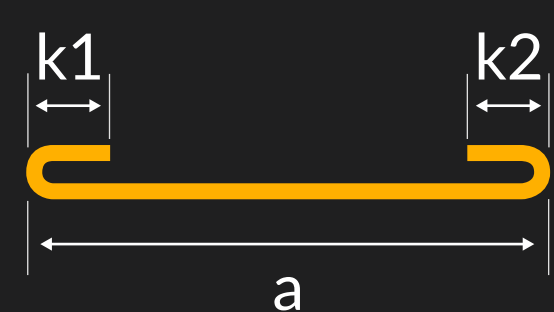

Formkode 00



Formkode 11

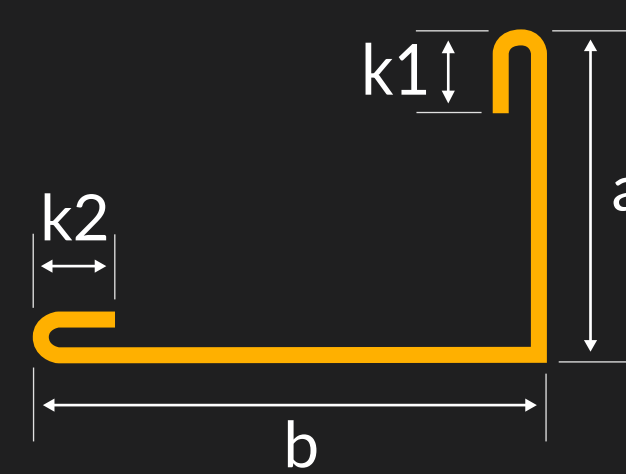

Formkode 12

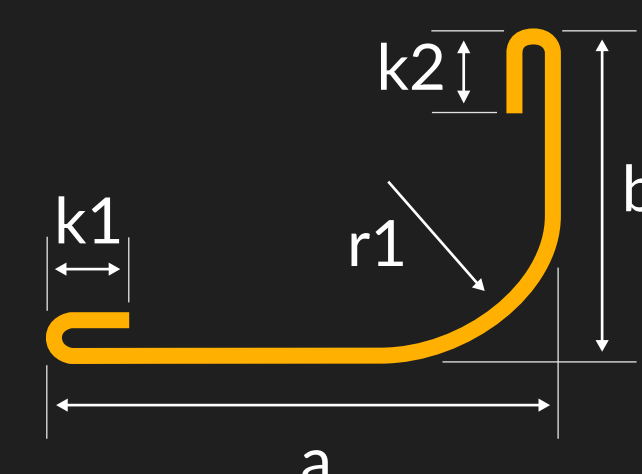

Formkode 13

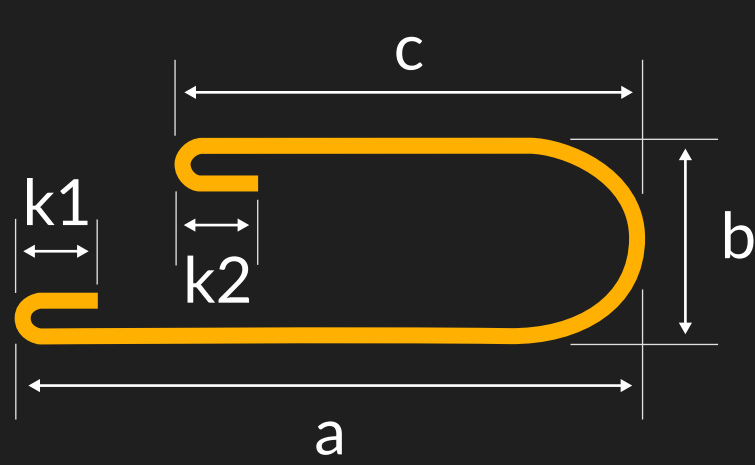

Formkode 15

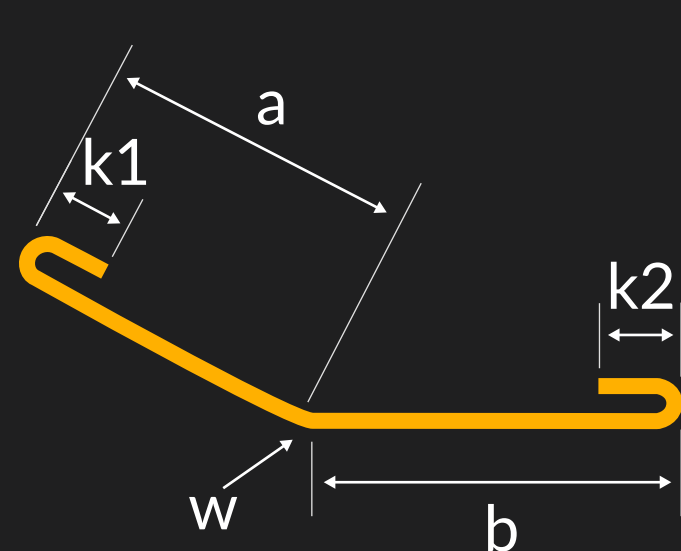

Formkode 21

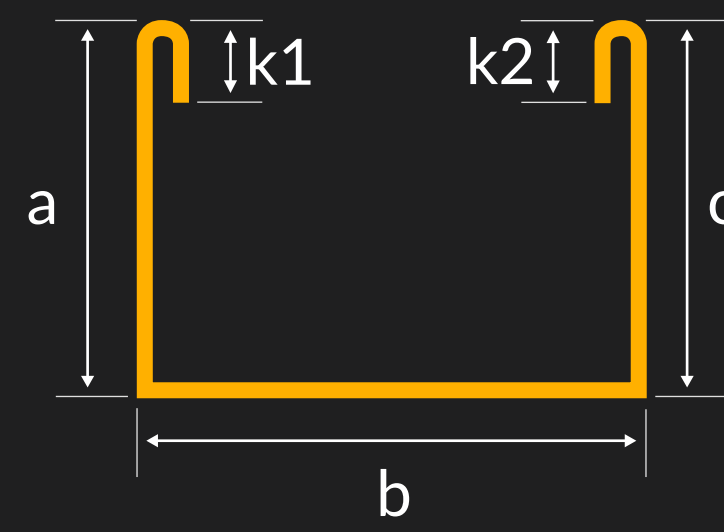

Formkode 25

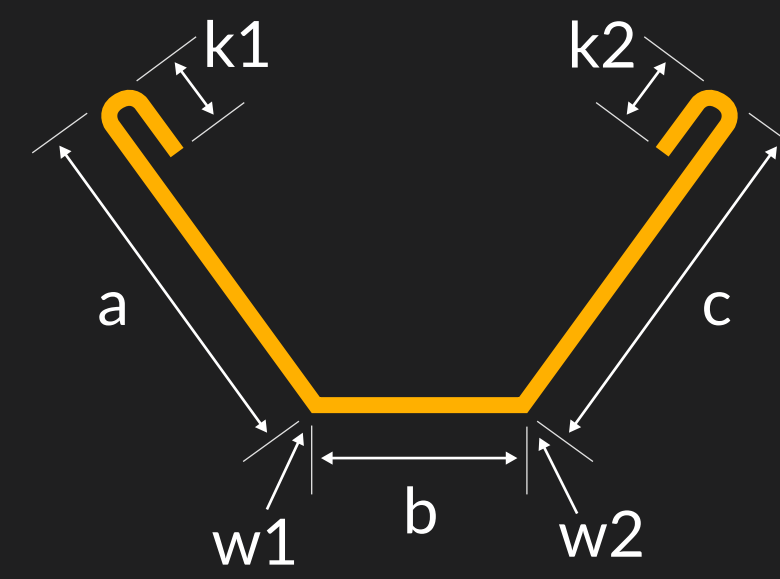

Formkode 26

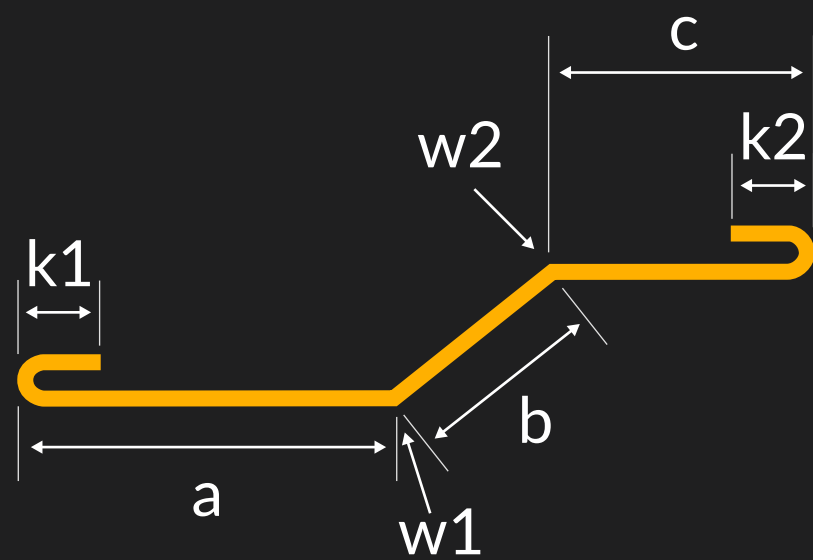

Formkode 31

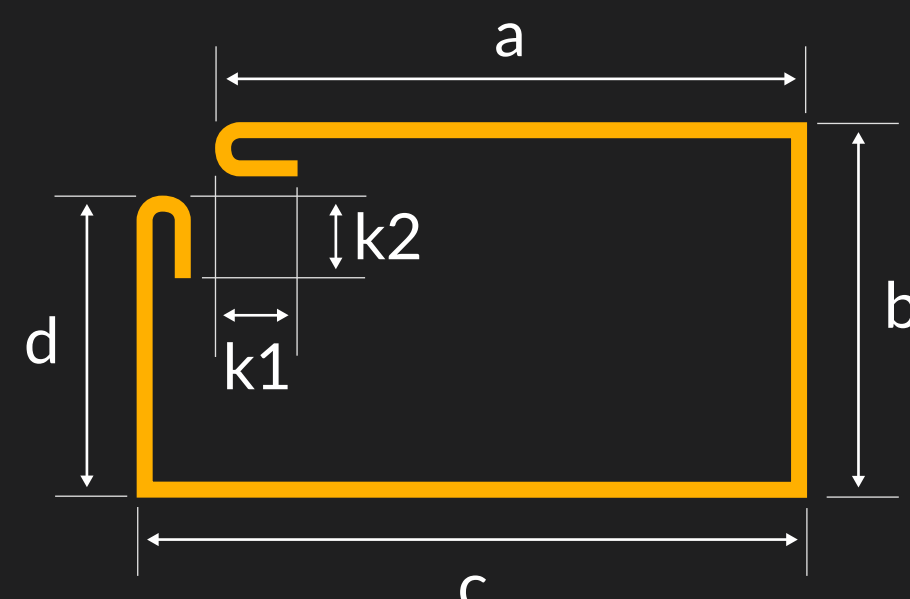

Formkode 33

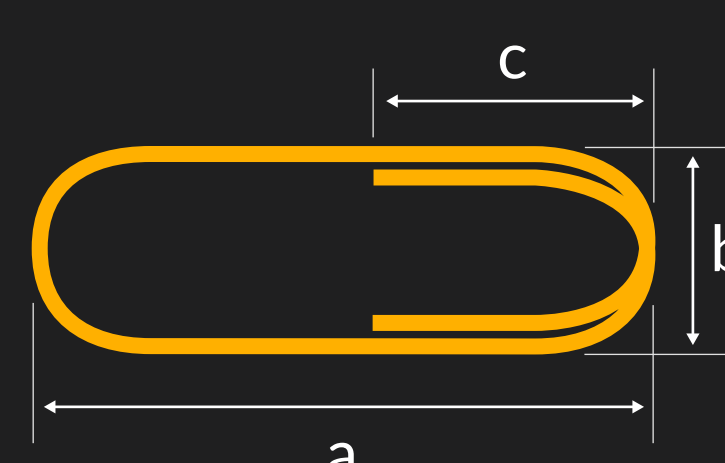

Formkode 41

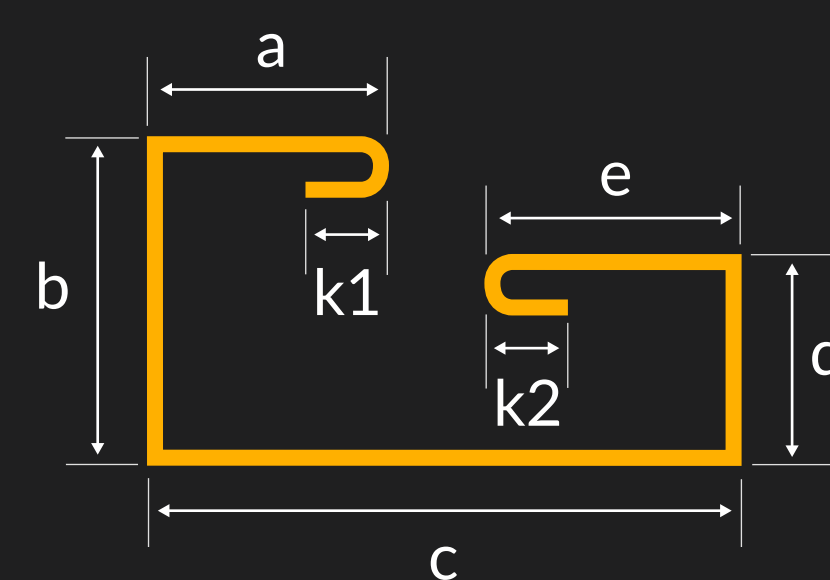

Formkode 44

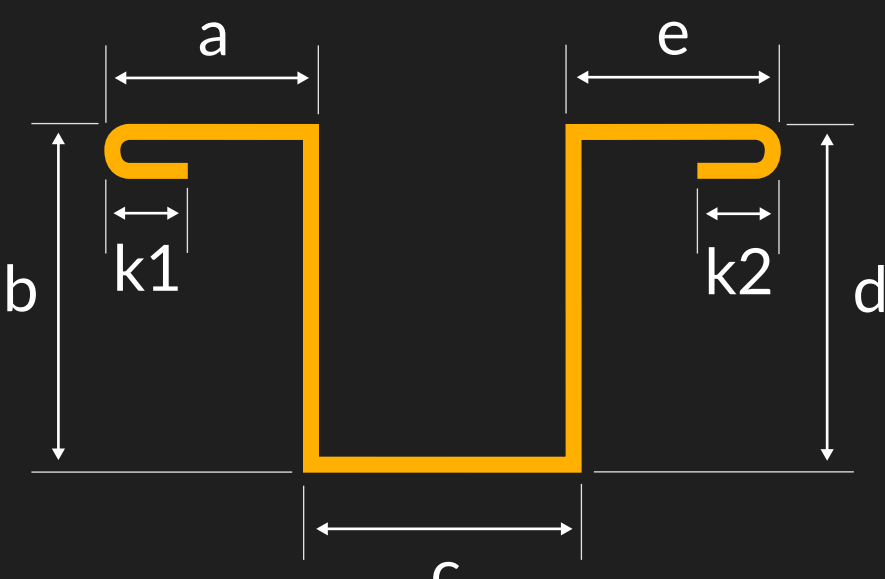

Formkode 46

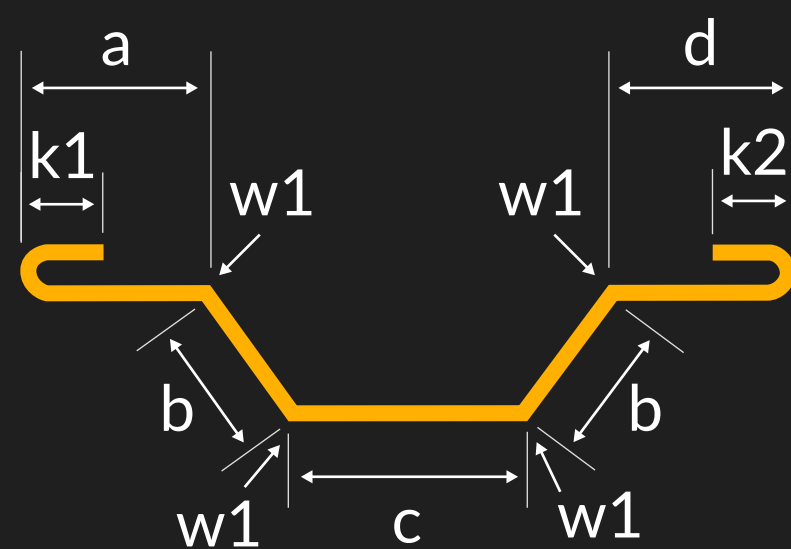

Formkode 51

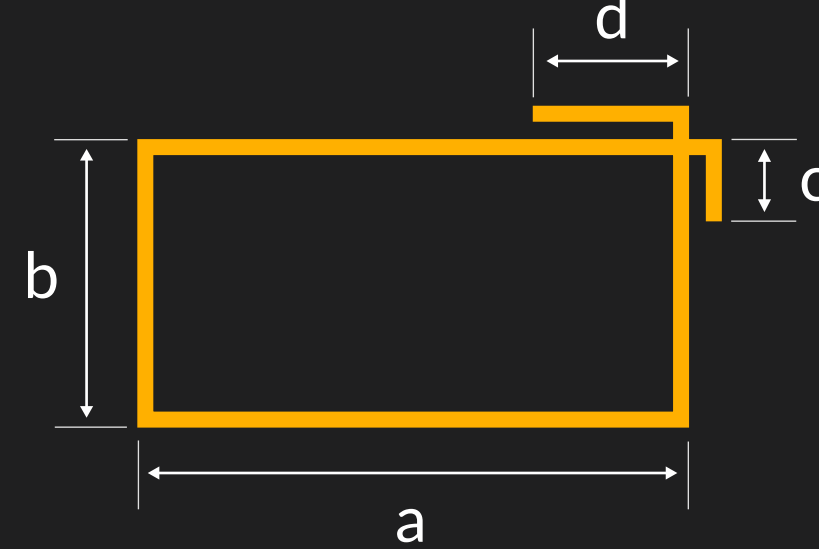

Formkode 67

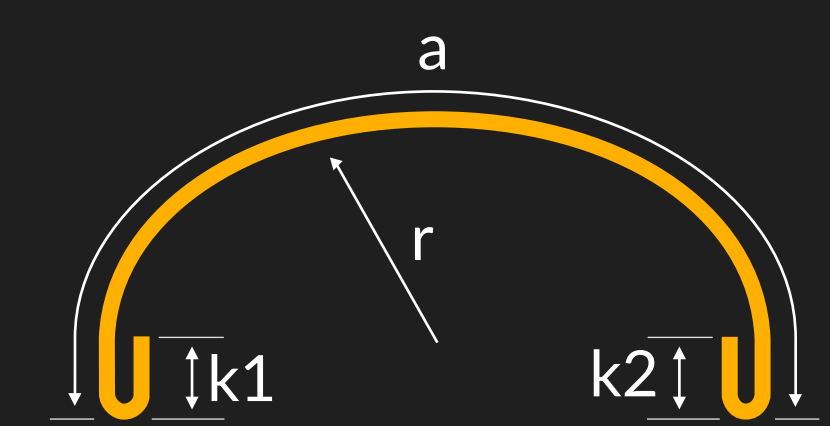

Formkode 77

Sirkulær spiral

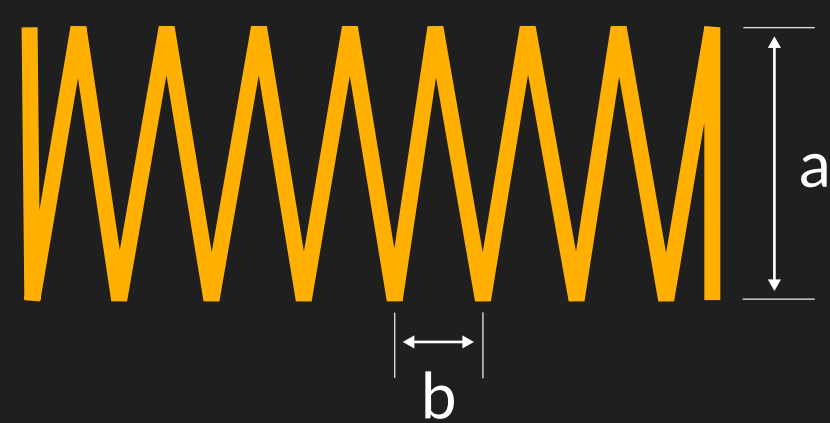

Formkode 106

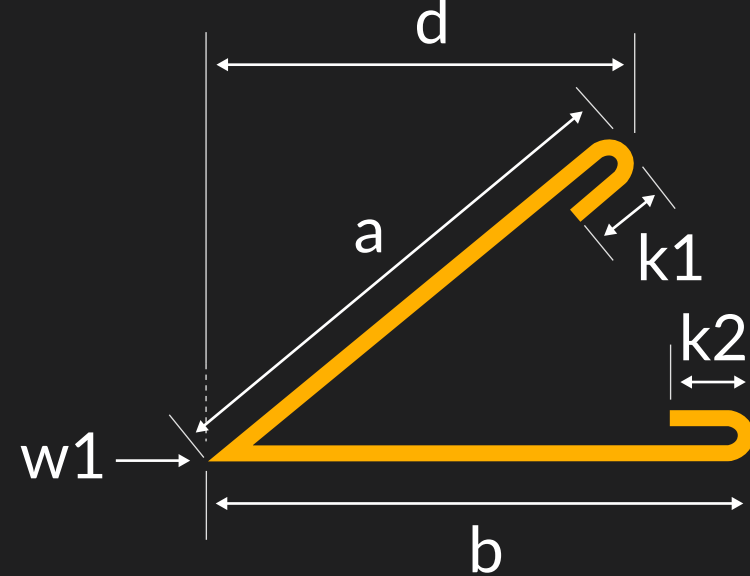

Formkode 109

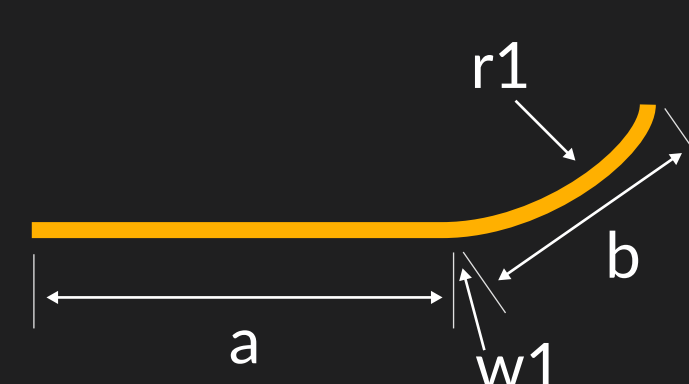

Formkode 110

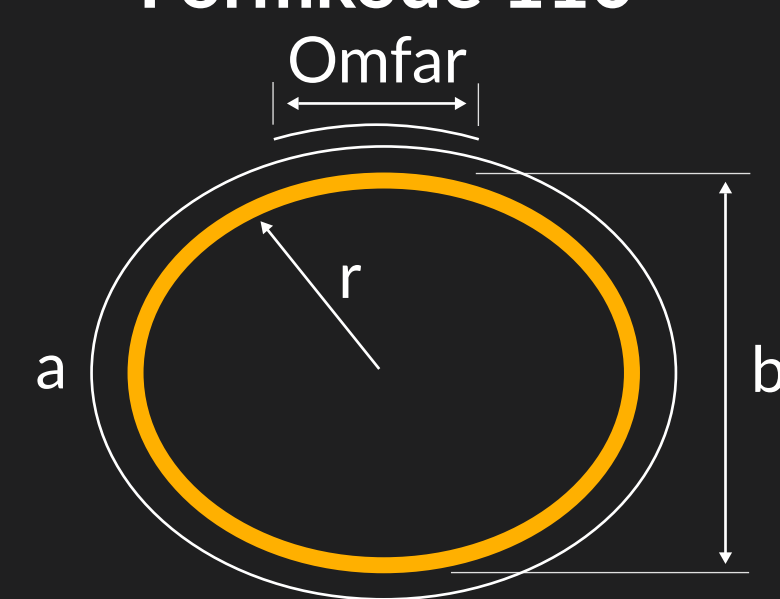

Formkode 206

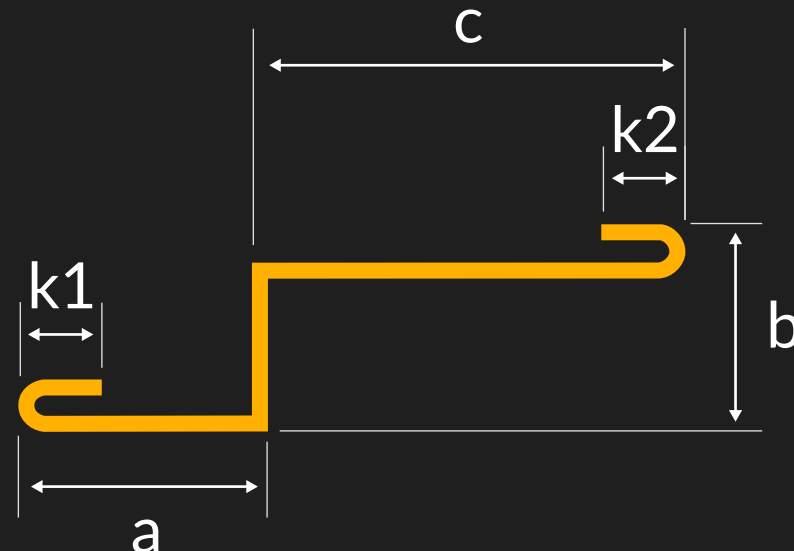

Formkode 212

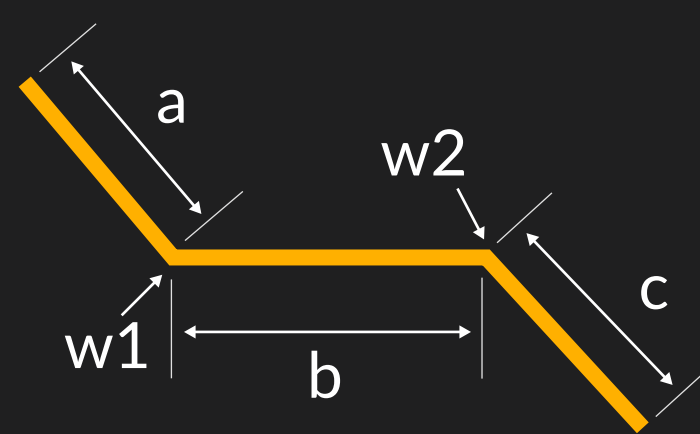

Formkode 214

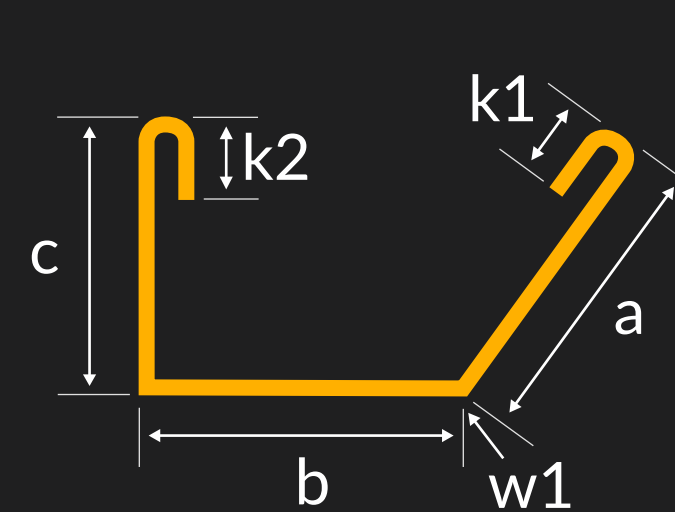

Formkode 215

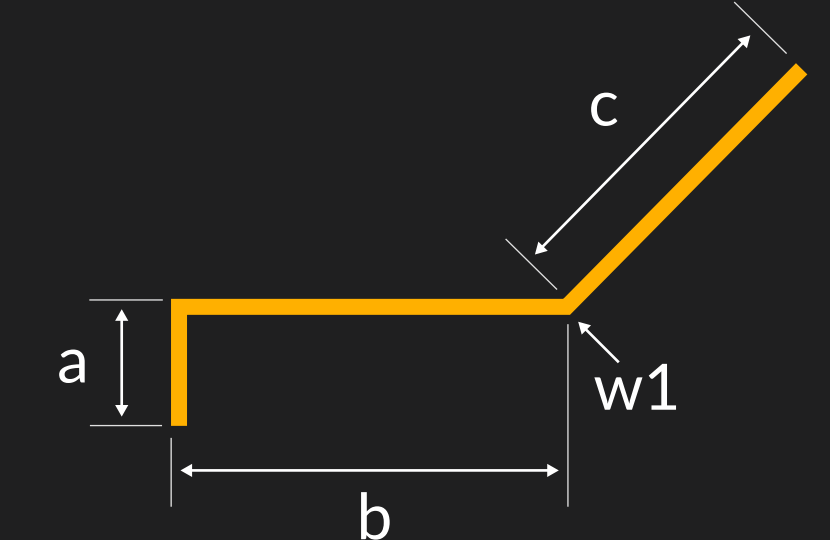

Formkode 217

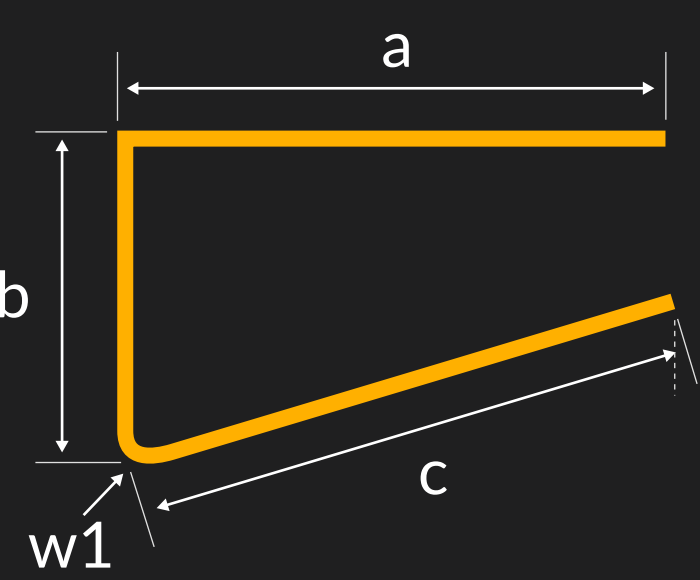

Formkode 219

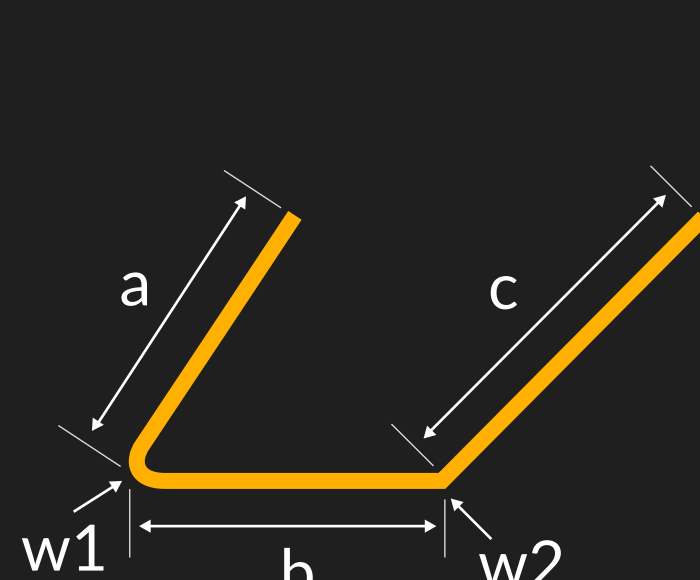

Formkode 224

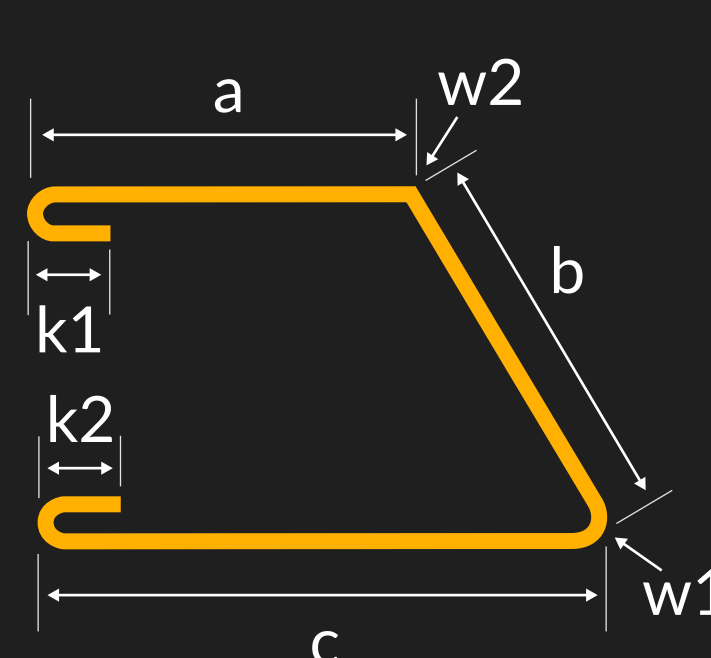

Formkode 240

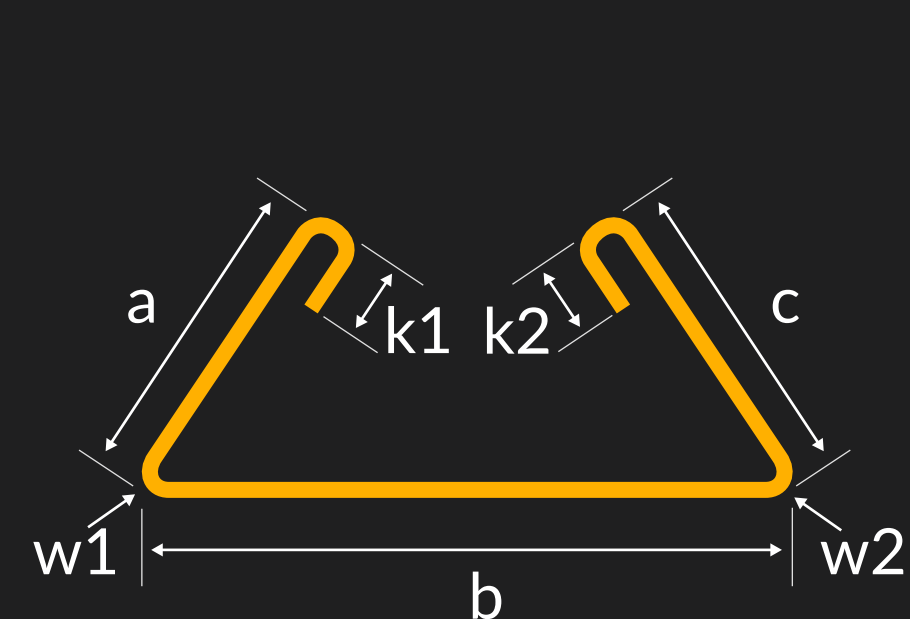

Formkode 307

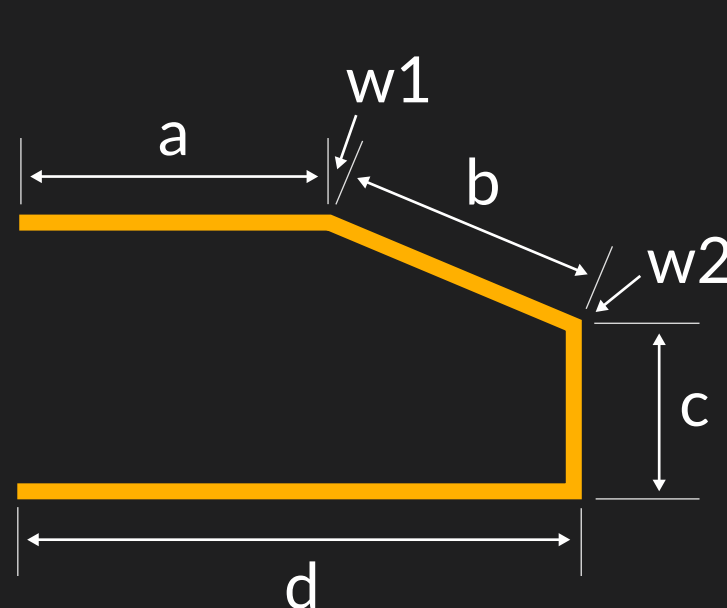

Formkode 310

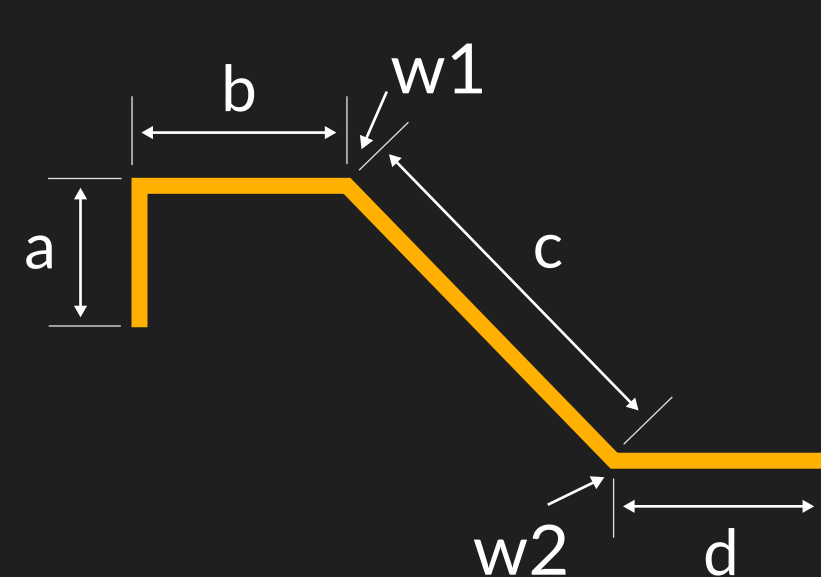

Formkode 314

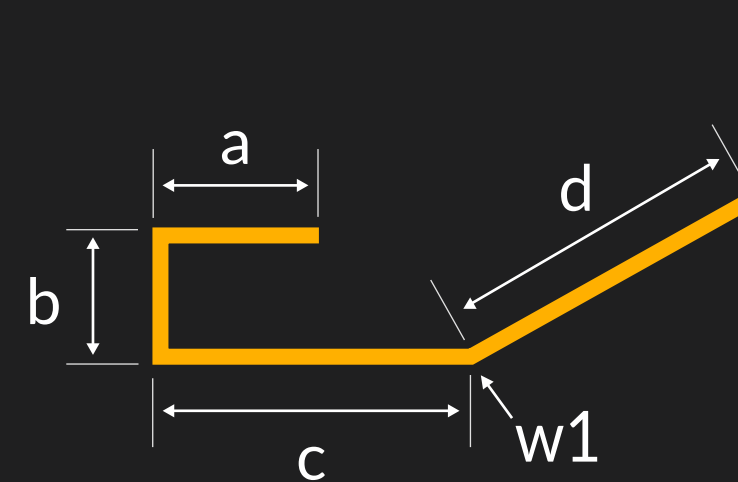

Formkode 426

Dekke hest

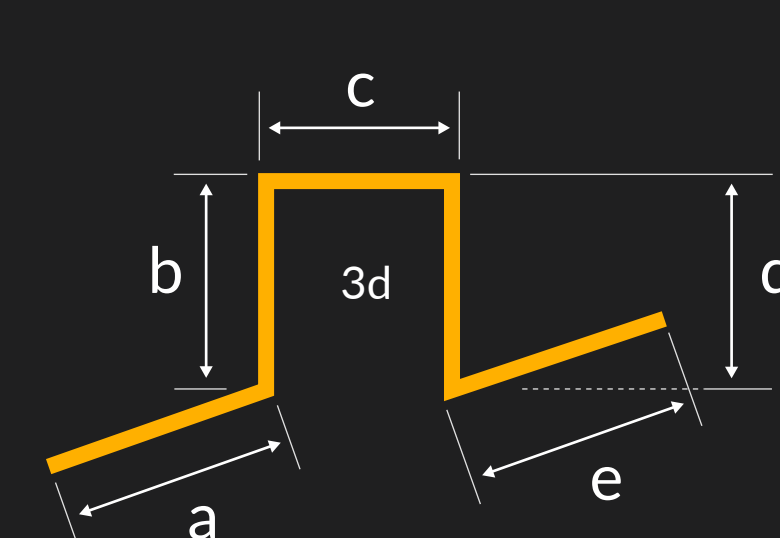

Formkode 519

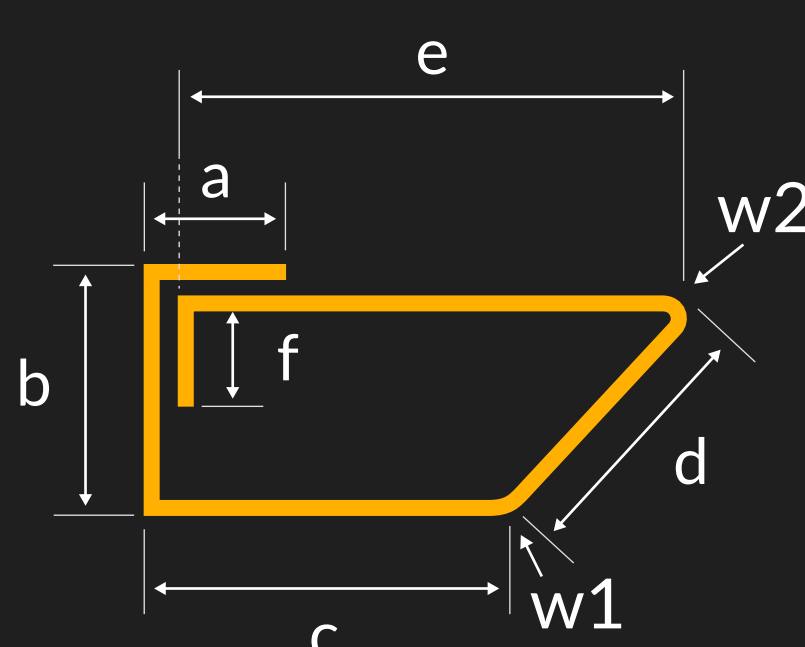

Armeringsnett

